

HRS50 Series – Isolated DC/DC Converters
48V Input (36 – 75Vdc), Maximum Power: 50WData Sheet
Sep 18, 2007**HRS50 Series 50W isolated DC/DC converters****Features**

- High Efficiency
- Wide operating temperature range
(-40°C to +85°C)
- Wide 2:1 input range
- Standard half brick size
- Six side shield
- Input – Output Isolated
- Built-in over temperature protection circuit
- Output over voltage protection
- Over current protection
- Input under voltage lock out
- Remote on/off control
- Trimmable output voltage
- Safety agency approval
UL (UL 60950-1, CSA C22.2 NO.60950-1):
pending
CE (EN 60950): pending
- RoHS directive

**Applications**

- Telecommunication
- Datacom
- Instrumentation/ Equipments
- Distributed Power Systems
- Railway

Description

HRS50 Series is a high efficiency isolated DC/DC converter provide up to 50 watt output power. This module achieved a high efficiency by employing an active clamp and synchronous rectification topology. It has a wide operating temperature from -40°C to +85°C. This module has a precise thermal protection circuit and it gives a high reliability.

HRS50 Series – Isolated DC/DC Converters
 48V Input (36 – 75Vdc), Maximum Power: 50W

 Data Sheet
 Sep 18, 2007

Absolute Maximum Ratings

Parameter	Min	Typ	Max	Unit	Notes
Input Voltage Continuous	36	-	76	Vdc	
Operating Ambient Temperature	-40	-	85	°C	
Storage Temperature	-40	-	100	°C	
I/O Isolation Voltage	-	-	1500	VAC	

Stresses in excess of the absolute maximum ratings can cause permanent damage to the device

Electrical Specifications

Input Characteristics

Parameter	Symbol	Min	Typ	Max	Unit
Operating voltage Range		36		76	Vdc
Maximum Input current (At nominal input voltage and Maximum Output Power)	I_{in}		1.16@3.3V 1.14@5V 1.15@12V 1.15@15V 1.15@24V		A
No load input current					
HRS50-48-3R3			30		mA
HRS 50-48-5			45		mA
HRS 50-48-12			92		mA
HRS 50-48-15			70		mA
HRS 50-48-24			12		mA
Input reflected ripple current (At rated input voltage and Maximum Output Power)					mA
Input Ripple Rejection voltage (pk to pk)	V_{jac}				Vdc
Inrush current(peak)	V_{p-p}				A
Disabled input current (Remote on/off control)					mA

HRS50 Series – Isolated DC/DC Converters
 48V Input (36 – 75Vdc), Maximum Power: 50W

 Data Sheet
 Sep 18, 2007

Output Characteristics

 T_A = +25°C, V_{in} = 36 ~ 75V unless otherwise specified

Parameter	Symbol	Min	Typ	Max	Unit
Output Voltage tolerance	V _o	-	-	±2	%
Output Current	I _o				
HRS50-48-3R3				15	A
HRS 50-48-5				10	A
HRS 50-48-12				4.1	A
HRS 50-48-15				3.3	A
HRS 50-48-24				2.1	A
Output Regulation;					
- Line Regulation		-	-	±0.5	%
(From minimum input voltage to maximum input voltage, constant load)					
- Load Regulation		-	-	±1	%
(From 10% load to maximum load)					
Output Current Limit (Automatic recovery)		>105			%
Output Ripple and noise (V _{in} = 24V, and I _o = Max output current Bandwidth 20MHz, 1uF Ceramic cap)	mVp-p	-	-	75@5V 120@12V 150@15V 240@24V	mV
Efficiency					
HRS50-48-3R3			87		%
HRS 50-48-5			91		%
HRS 50-48-12			89		%
HRS 50-48-15			89		%
HRS 50-48-24			90		%
(100% of max I _o , V _{in} = 48V)					
Dynamic Load Response (10uF Tantal Capacitor) 25% to 50 %, 50% to 25%,			±	3% of Output Voltage	mV

HRS50 Series – Isolated DC/DC Converters
48V Input (36 – 75Vdc), Maximum Power: 50W

 Data Sheet
 Sep 18, 2007

Slew rate = 0.05A/uS)					
Recovery Time (with in 1% Nominal Vo)					us
Start – Up Time		-	-	10	ms
Turn – on overshoot		-	-	5	%
Maximum output capacitance (@5V)				4700	μF

Isolation Specifications

Parameter	Symbol	Min	Typ	Max	Unit
I/O Isolation Voltage (AC1500V, 1 Min)					
- Input-Output:			-	1500	VAC
- Input-Case:			-	1500	VAC
- Output-case:			-	1500	VAC
Isolation Resistance - Output-Case (at DC500V at 25°C And 70%RH for 1 min)	Riso	>100	-	-	MΩ
Isolation Capacitance	Ciso				pF

General Specifications

Parameter	Symbol	Min	Typ	Max	Unit
Switching Frequency			300		KHz
Remote ON/OFF control On = short to - Vin Off = open					Vdc

Output voltage trim range			±10		%
MTBF		4.5x10 ⁵			hrs

HRS50 Series – Isolated DC/DC Converters
48V Input (36 – 75Vdc), Maximum Power: 50WData Sheet
Sep 18, 2007

Dimensions (W.H.L)		61 x 12.7 x 57.9 (2.4 x 0.5 x 2.28))			mm (inches)
Weight		-	75	-	Grams

Environmental

Parameter	Symbol	Min	Typ	Max	Unit
Operating Temperature		-40		85	°C
Operating Humidity (RH non-condensing)		5		95	%
Storage Temperature		-40		105	°C
Shock					
Vibration					

HRS50 Series – Isolated DC/DC Converters
48V Input (36 – 75Vdc), Maximum Power: 50W

Data Sheet
 Sep 18, 2007

Characteristic Curves
Efficiency Curves

HRS50-48-3R3

Efficiency curve vs load

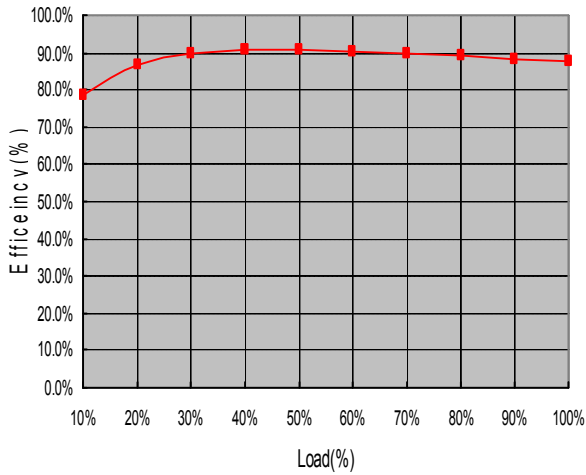

Vin=48V, Vo=3.3V@15A , At 25°C

HRS50-48-5

Efficiency curve vs load

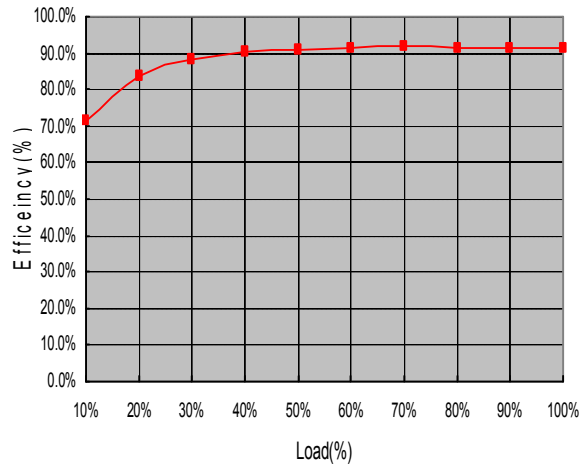

Vin=48V, Vo=5V@10A , At 25°C

HRS50-48-12

Efficiency curve vs load

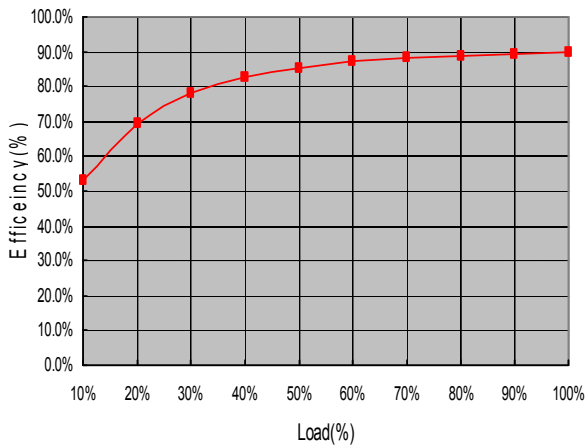

Vin=48V, Vo=12V@4.1A , At 25°C

HRS50-48-15

Efficiency curve vs load

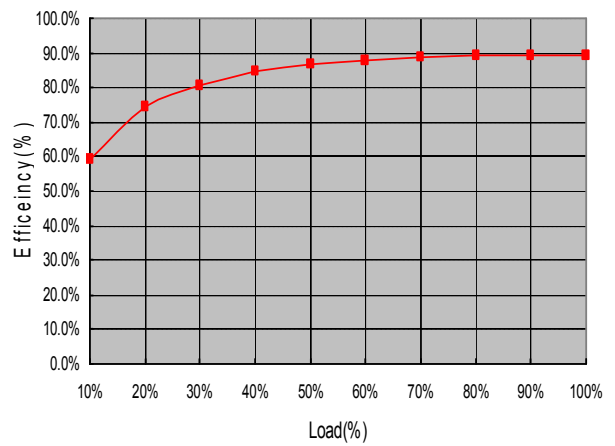

Vin=48V, Vo=15V@3.3A , At 25°C

HRS50 Series – Isolated DC/DC Converters
48V Input (36 – 75Vdc), Maximum Power: 50W

Data Sheet
 Sep 18, 2007

HRS50-48-24

Efficiency curve vs load

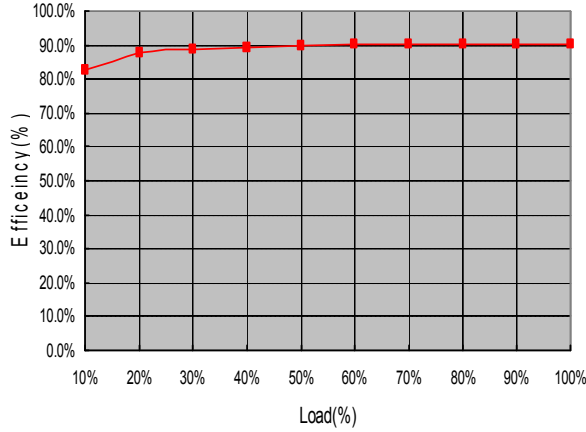

$V_{in}=48V, V_o=24@2.1A, \text{ At } 25^{\circ}C$

$V_o=3.3V@15A, \text{ At } 25^{\circ}C$

Input Voltage vs Input Current

HRS50-48-3R3

Input current vs input voltage

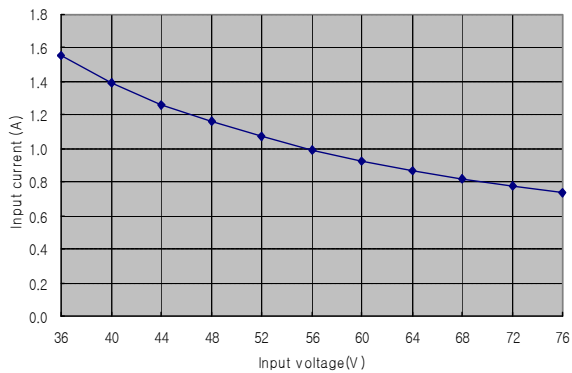

HRS50-48-5

Input current vs input voltage

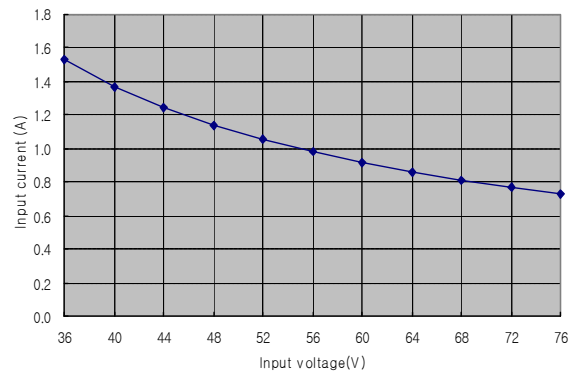

HRS50 Series – Isolated DC/DC Converters
48V Input (36 – 75Vdc), Maximum Power: 50W

Data Sheet
 Sep 18, 2007

$V_o=5@10A$, At 25°C

HRS50-48-12

Input current vs Input voltage

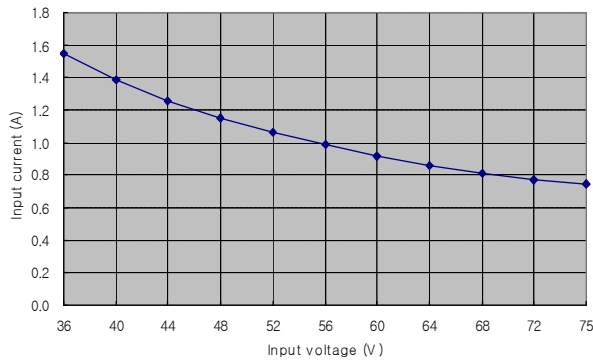

$V_o=12@4.1A$, At 25°C

HRS50-48-15

Input current vs input voltage

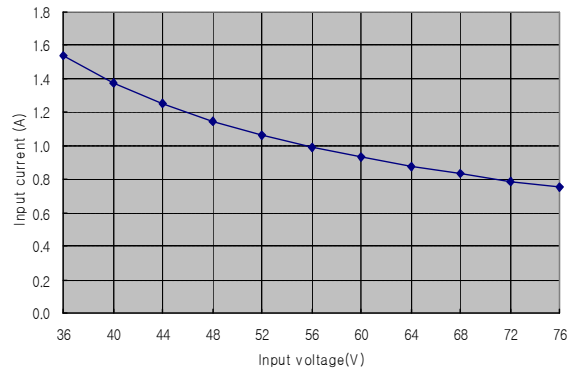

$V_o=15@3.3A$, At 25°C

HRS50-48-24

Input current vs input voltage

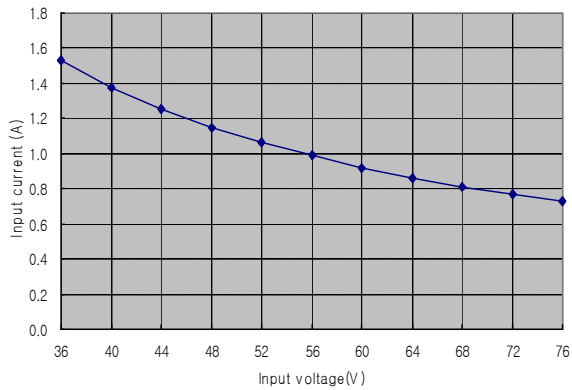

$V_o=24V@2.1A$, At 25°C

HRS50 Series – Isolated DC/DC Converters
48V Input (36 – 75Vdc), Maximum Power: 50W

Data Sheet
Sep 18, 2007

Output derating curve

HRS50-48-3R3

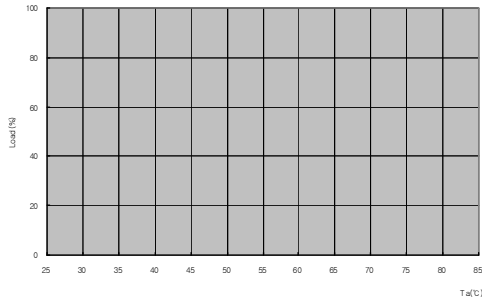

HRS50-48-5

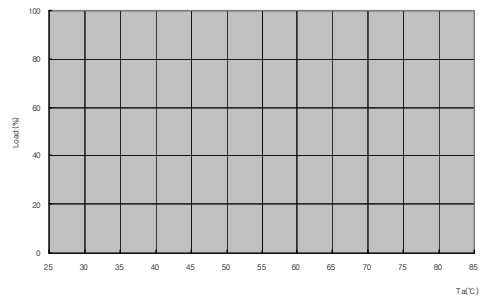

HRS50-48-12

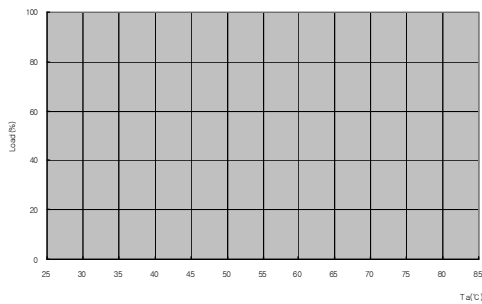

HRS50-48-15

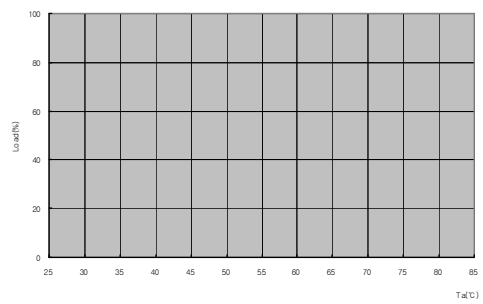

HRS50-48-24

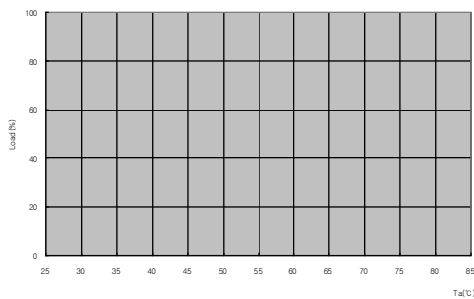

(Preparing)

HRS50 Series – Isolated DC/DC Converters
 48V Input (36 – 75Vdc), Maximum Power: 50W

Data Sheet
 Sep 18, 2007

Start-up from Vin

HRS50-48-3R3

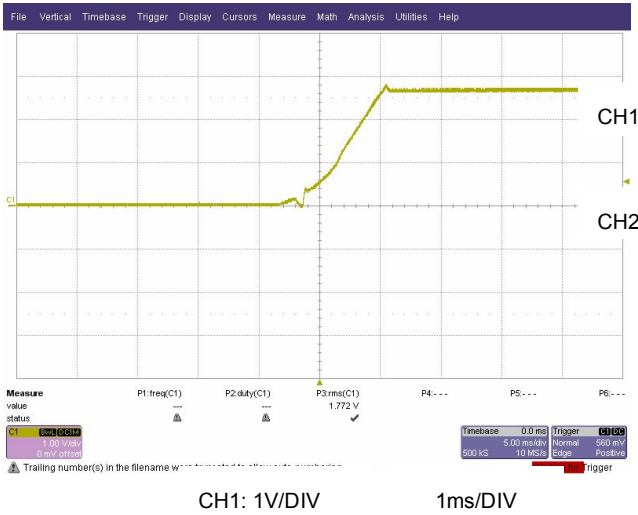

HRS50-48-5

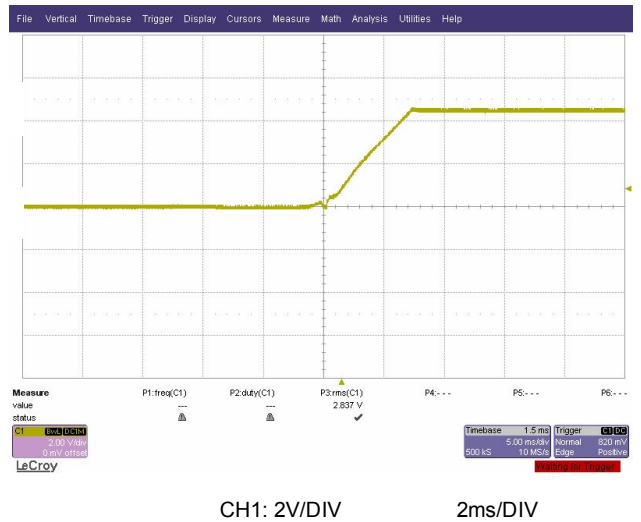

HRS50-48-12

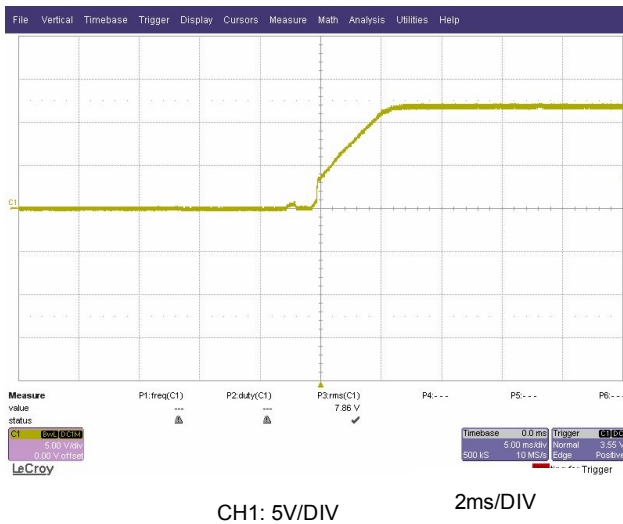

HRS50-48-15

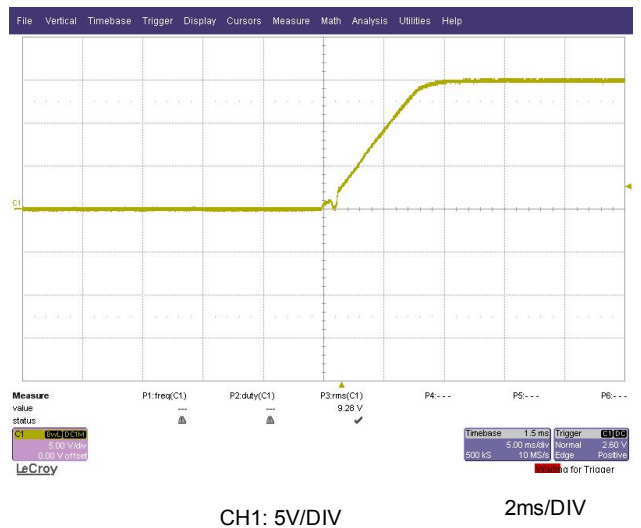

HRS50 Series – Isolated DC/DC Converters
48V Input (36 – 75Vdc), Maximum Power: 50W

Data Sheet
 Sep 18, 2007

HRS50-48-24

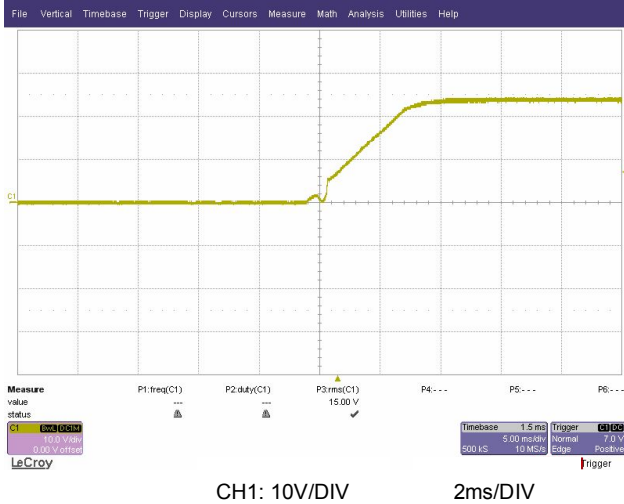

Output Ripple/Noise

HRS50-48-3R3

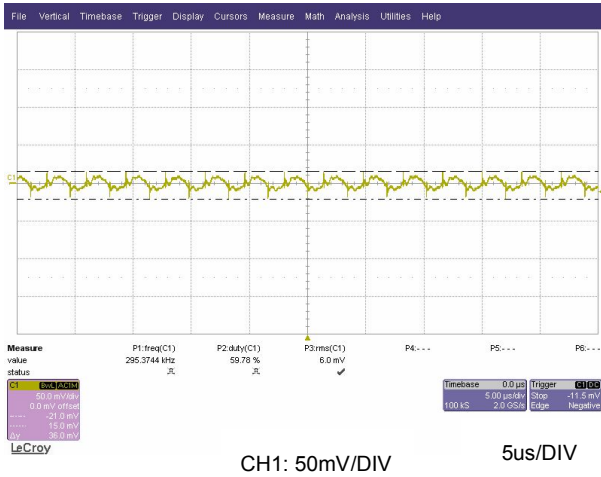

Vin=48V, Vo=3.3V@15A ,At 25°C

HRS50-48-5

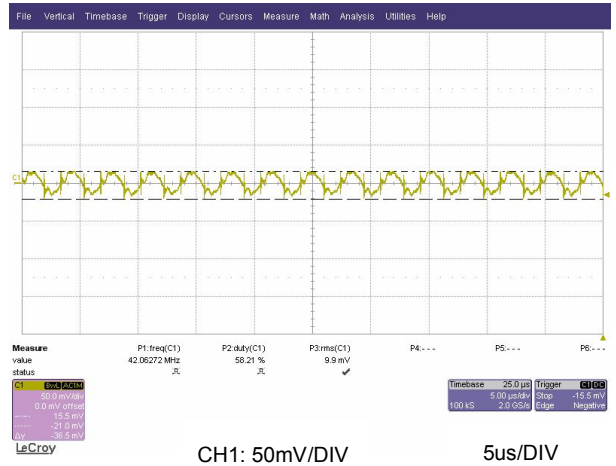

Vin=48V, Vo=5V@15A, At 25°C

HRS50 Series – Isolated DC/DC Converters
48V Input (36 – 75Vdc), Maximum Power: 50W

Data Sheet
 Sep 18, 2007

HRS50-48-12

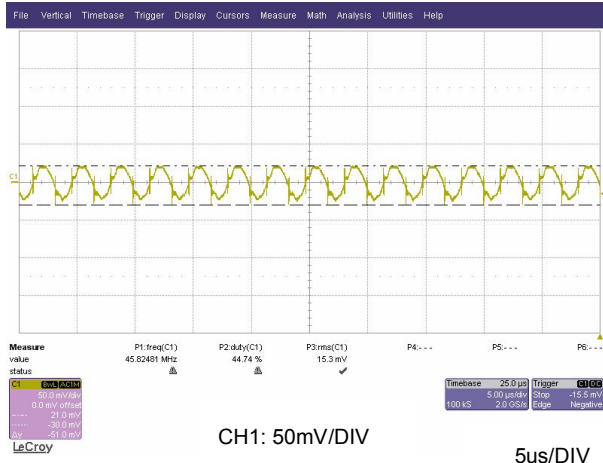

Vin=48V, Vo=12V@10A, At 25°C

HRS50-48-15

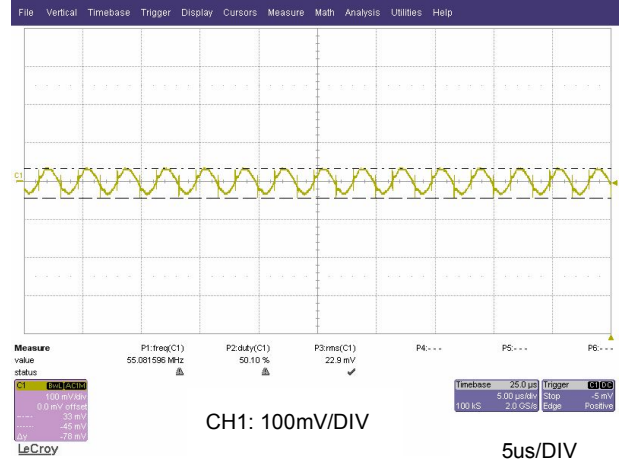

Vin=48V, Vo=15V@4.1A, At 25°C

HRS50-48-24

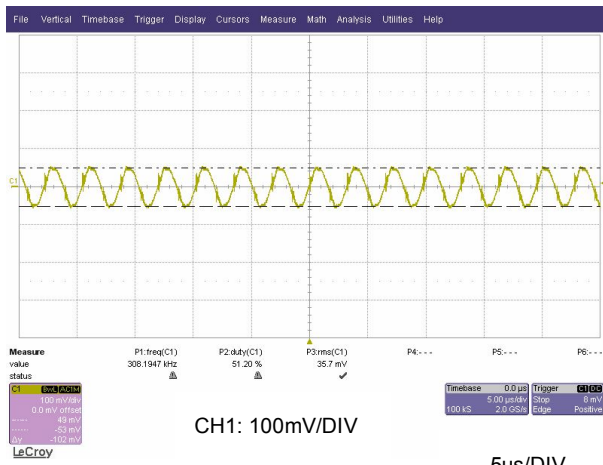

Vin=48V, Vo=24V@2.1A, At 25°C

HRS50 Series – Isolated DC/DC Converters
 48V Input (36 – 75Vdc), Maximum Power: 50W

Data Sheet
 Sep 18, 2007

Output Load Transient Response

(Dynamic load change from 25% to 50% to 25%
 of full load)

HRS50-48-3R3

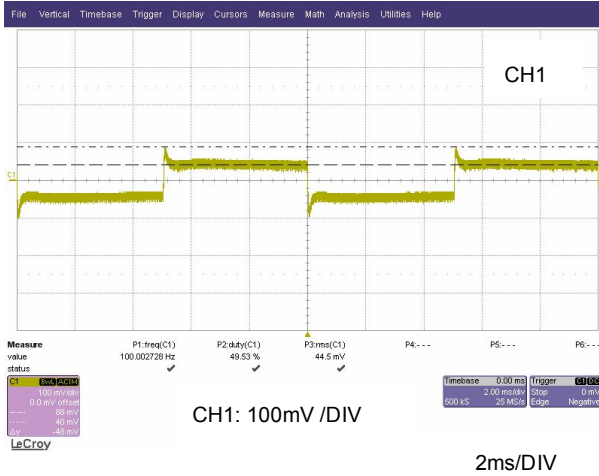

HRS50-48-5

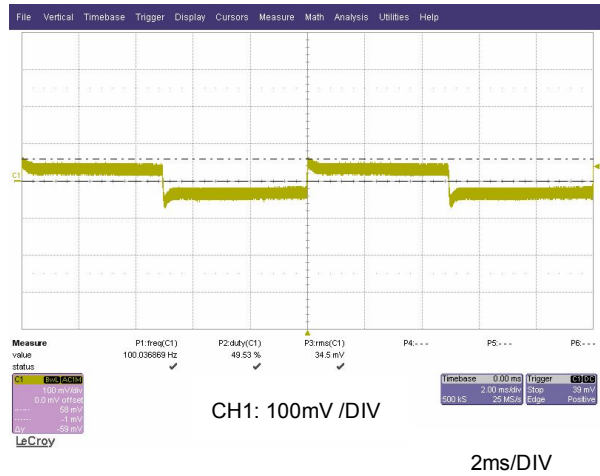

HRS50-48-12

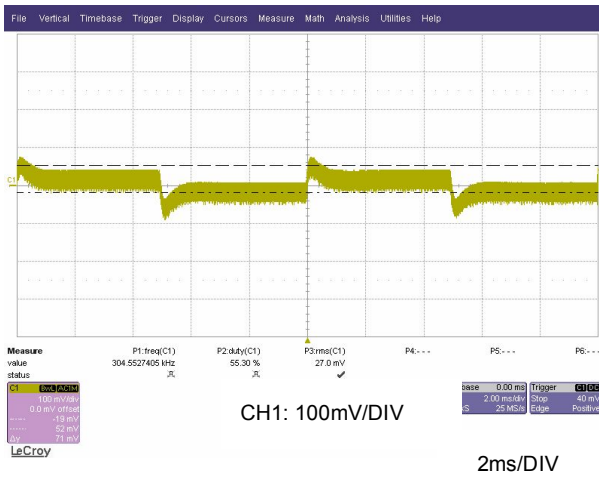

HRS50-48-15

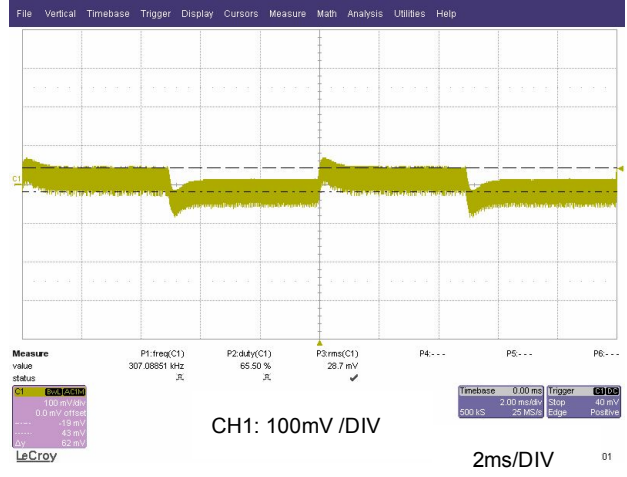

HRS50 Series – Isolated DC/DC Converters
48V Input (36 – 75Vdc), Maximum Power: 50W

Data Sheet
Sep 18, 2007

HRS50-48-24

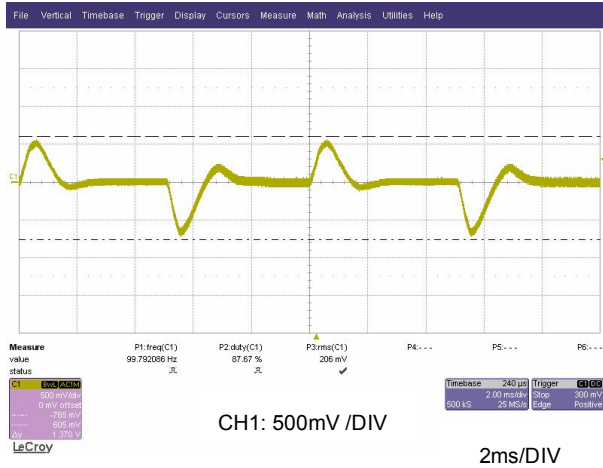

HRS50 Series – Isolated DC/DC Converters
 48V Input (36 – 75Vdc), Maximum Power: 50W

Data Sheet
 Sep 18, 2007

TEST Configurations

Input Reflected Ripple Current Test

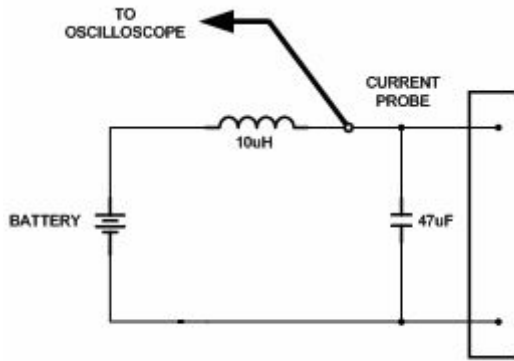

Efficiency

$$\eta = \left(\frac{[V_o(+)-V_o(-)] \times I_o}{[V_{in}(+)-V_{in}(-)] \times I_{in}} \right) \times 100\%$$

Thermal Considerations

HRS50 series has wide operating temperature range from -40°C to +85°C.

However, it should be required an enough air flow for more reliable operation. Output derating curve provide designers with a quantity of a current under the desired ambient temperature and velocity of a airflow

Output ripple and noise Test

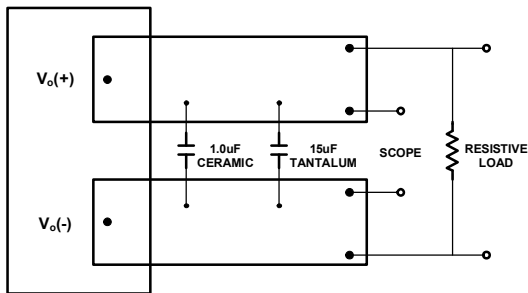

* Conductor from Vout-pins to capacitors = 50mm (1.97in)

If the device is installed in a system, the device's temperature of point A should be checked if it does not exceed specified temperature as below. Please make sure that the temperature of point A does not exceed 100°C. HRS50 series has a precise thermal shunt down circuit. If the temperature of point A exceed a 100°C over temperature protection circuit will operate and output shunt down. As the temperature goes down the output will recover automatically.

Output Voltage and Efficiency Test

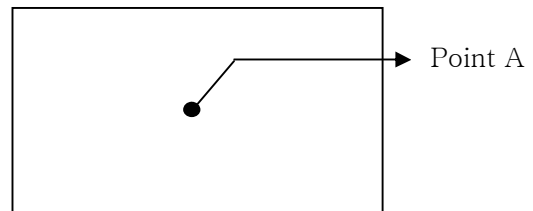
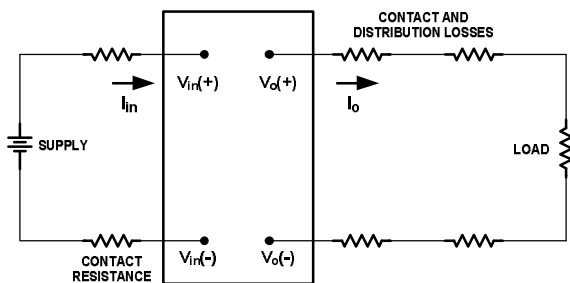

*All measurements are taken at the module terminals when Socketing, place Kelvin connections at module terminals to Avoid measurement errors due to socket contact resistance

HRS50 Series – Isolated DC/DC Converters
 48V Input (36 – 75Vdc), Maximum Power: 50W

Data Sheet
 Sep 18, 2007

Feature Description

Input Fuse

HRS50 series has not built in internal fuse. Therefore in order to ensure protection and safety fuses should be used at input line of converter

We recommend to use a slow blow type fuse with a typical value of about twice the maximum input current, calculated at low line with the converter minimum efficiency.

Input Reverse-polarity voltage protection

Input reverse voltage protection has not built in this product.

So, you can set up a circuit externally as described below if necessary

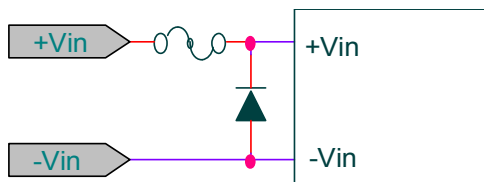

Input Output Filter

HRS50 series have an internal input filter. To minimize the ripple and noise of the input voltage, additional external capacitor is required. To reduce an output ripple and noise, external capacitor is required at the output of the device.

Remote ON/OFF Control (CNT)

By using CNT pin you can control the output without turning the input power on or off.

If you need not this function open this pin

CNT Level for -Vin	OUTPUT
Open	OFF
Short	ON

Output voltage variation (Trim)

Output Voltage adjusted by using trim pin within $\pm 10\%$ of output voltage.

Use of trim function can cause the output power to increase, so you should not use beyond the this module's specified output power rating

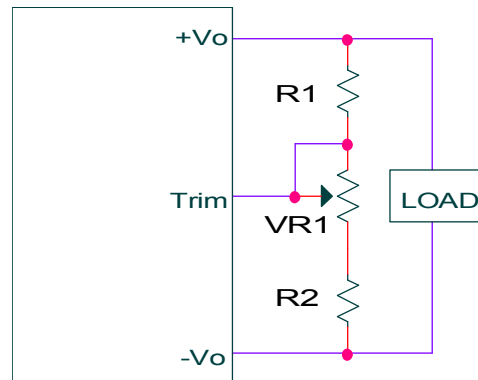

Output voltage	VR	R1	R2
3.3V	500Ω	1kΩ	560Ω
5V	1kΩ	1kΩ	680Ω
12V	1kΩ	3.9kΩ	680Ω
15V	1kΩ	5.6kΩ	750Ω
24V	2kΩ	24kΩ	2kΩ

HRS50 Series – Isolated DC/DC Converters
48V Input (36 – 75Vdc), Maximum Power: 50WData Sheet
Sep 18, 2007**Over current Protection(OCP)**

HRS50 series built in over current protection circuit which operates when the output current is over 105% of rating and automatically recovers when over current condition is removed

Over Voltage Protection(OVP)

HRS50 series built in over voltage protection circuit which operates when the output voltage within 115~140% of rating. When OVP is triggered, the input must be taken out for second and then reinputed manually.

Soldering Information

The product is intended for through hole mounting in a PCB, When wave soldering is used, the temperature on the pins is specified to maximum 260°C for maximum 10 seconds when hand soldering, care should be taken to avoid direct contact between the hot soldering iron tip and the pins for more than a few seconds in order to prevent overheating.

HRS50 Series – Isolated DC/DC Converters
 48V Input (36 – 75Vdc), Maximum Power: 50W

Data Sheet
 Sep 18, 2007

Mechanical Specification

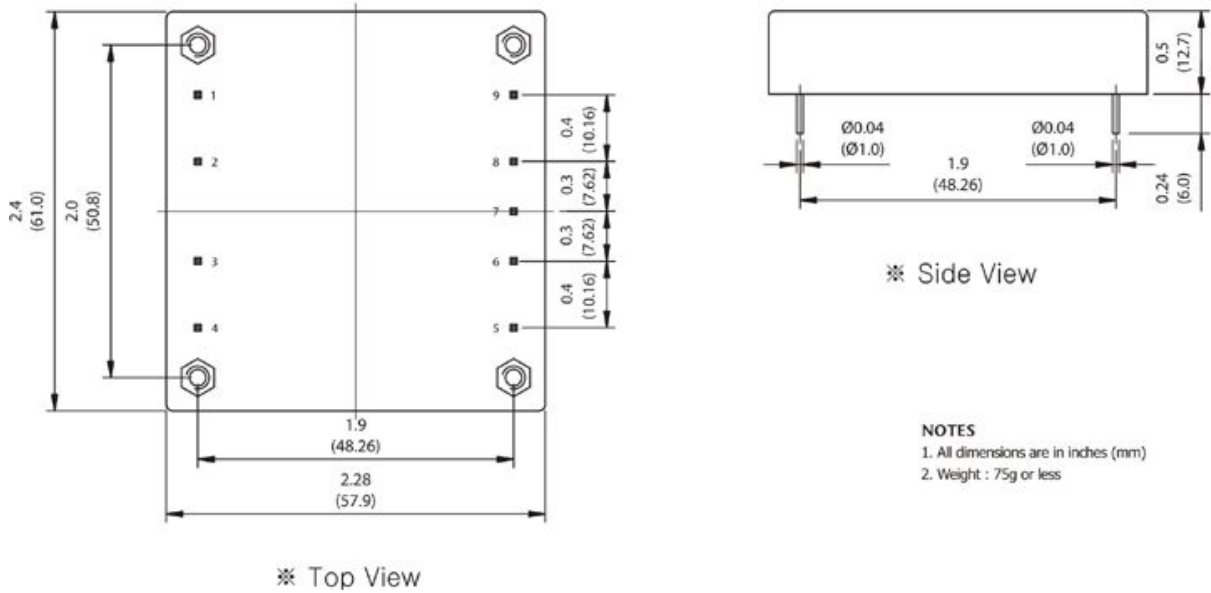

PIN NO	NAME	FUNCTION
1	+Vin	Positive terminal for Vin
2	CNT	Logic signal reference to Vin to Turn the converter ON/OFF
3	CASE	CASE
4	-Vin	Negative terminal for Vin
5	-Vout	Negative terminal for Vout
6	No pin	-
7	Trim	Output voltage variation
8	No pin	
9	+Vout	Positive terminal for Vout

HRS50 Series – Isolated DC/DC Converters
 48V Input (36 – 75Vdc), Maximum Power: 50W

 Data Sheet
 Sep 18, 2007

Ordering Information

Input	Output1	Maximum Power	Ripple & Noise Typ.	Efficiency Typ.	Model Number
36 – 76V	3.3V@15A	49.5W	75mVp-p	87%	HRS50-48-3R3
	5V@10A	50W	75mVp-p	91%	HRS50-48-5
	12V@4.1A	49.2W	120mVp-p	89%	HRS50-48-12
	15V@3.3A,	49.5W	150mVp-p	89%	HRS50-48-15
	24V@2.1A,	50.4W	240mVp-p	90%	HRS50-48-24
50 – 100V	3.3V@15A	49.5W	75mVp-p	86%	HRS50-72-3R3
	5V@10A	50W	75mVp-p	87%	HRS50-72-5
	12V@4.1A	49.2W	120mVp-p	88%	HRS50-72-12
	15V@3.3A,	49.5W	150mVp-p	87%	HRS50-72-15
	24V@2.1A,	50.4W	240mVp-p	87%	HRS50-72-24
65 – 150V	3.3V@15A	49.5W	75mVp-p	86%	HRS50-96-3R3
	5V@10A	50W	75mVp-p	89%	HRS50-96-5
	12V@4.1A	49.2W	120mVp-p	86%	HRS50-96-12
	15V@3.3A,	49.5W	150mVp-p	87%	HRS50-96-15
	24V@2.1A,	50.4W	240mVp-p	89%	HRS50-96-24

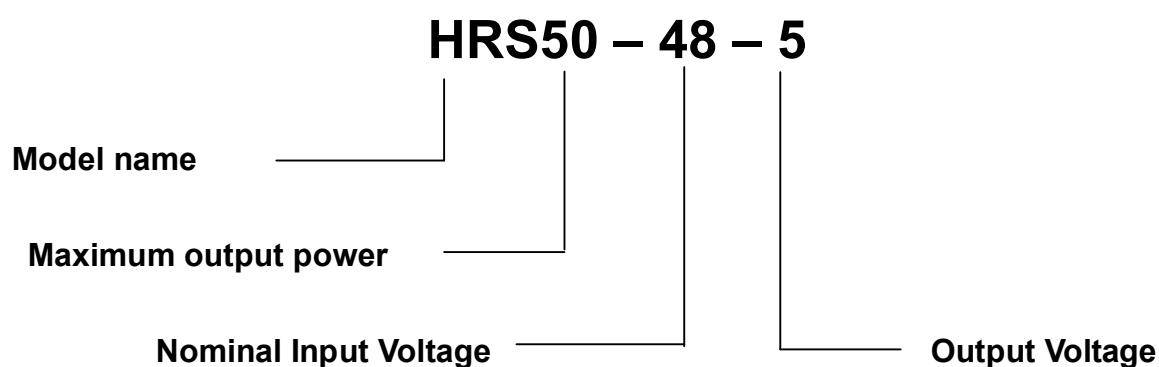
Part number structure

HRS50 Series – Isolated DC/DC Converters
48V Input (36 – 75Vdc), Maximum Power: 50WData Sheet
Sep 18, 2007

No part of this publication may be copied, transmitted, or stored in a retrieval system or reproduced in any way including, but not limited to, photography, photocopy, or Other recording means, without prior written permission from Powerplaza co.,Ltd

**HEAD OFFICE & FACTORY**

#1402, 14F/L 6th Daeryung TechnoTown 493-6,
Gasan-Dong, Kumchon-Gu, Seoul, 153-774,
Korea

TEL: +82 2 855 4955 | FAX: +82 2 855 4954

GENERAL SALES INQUIRIES

Please feel free to

contact : sales@powerplaza.co.kr

©2007 Powerplaza co.,Ltd. Specification subject to change without notice