

SPT15 Series – Isolated DC/DC Converters
20 – 72Vdc Input, Maximum Power: 15WData Sheet
JUNE 1, 2011**SPT15 Series –small size isolated DC/DC converters****Features**

- High Efficiency
- Small size (2 x 1.3 inch)
- Wide operating temperature range
(-20°C to +71°C)
- Wide 4:1 input range
- Built – in over current protection circuit
- Input – Output Isolated
- Remote on/off control
- Trimmable output voltage
- Six side shield case type
- Long Life Design
(Employ only ceramic capacitor)
- Safety agency approval : Pending
UL (UL 60950,CSA C22.2 NO.60950):
E227474
CE (EN 60950) through TÜV
- RoHS directive

**Applications**

- Telecommunication
- Datacom
- Instrumentation
- Distributed Power System

Description

SPT15 Series is a high efficiency isolated DC/DC converter provide up to 15 watt output power. This module offers a cost effective solution for many space critical applications. It has a ultra wide 4:1 input voltage range include remote on/off, trimable output , over current protection function.

High efficiency make the wide operating temperature range from -20°C to 71°C. SPT series ideal for mixed analog/digital Subsystems, data communication equipments, distributed power systems.

SPT15 Series – Isolated DC/DC Converters
20 – 72Vdc Input, Maximum Power: 15WData Sheet
JUNE 1, 2011**Absolute Maximum Ratings**

Parameter	Min	Typ	Max	Unit	Notes
Input Voltage Continuous	20	-	72	VDC	
Operating Ambient Temperature	-20	-	71	°C	
Storage Temperature	-40	-	105	°C	
I/O Isolation Voltage	-	-	500	VAC	

Stresses in excess of the absolute maximum ratings can cause permanent damage to the device

Electrical Specifications**Input Characteristics**

Parameter	Symbol	Min	Typ	Max	Unit
Operating voltage Range		20		72	Vdc
Maximum Input current (At nominal input voltage and Maximum Output Power)	I_{in}		0.36		A (@5V)
No load Input Current					mA
SPTS15-48-3R3			24		
SPTS15-48-5			28		
SPTS15-48-12			8		
SPTS15-48-15			9		
Disabled input current SPTS15-48-5 (Remote on/off control)					mA

SPT15 Series – Isolated DC/DC Converters
20 – 72Vdc Input, Maximum Power: 15W

 Data Sheet
 JUNE 1, 2011

Output Characteristics
 $T_A = +25^\circ\text{C}$ $V_{in} = 20 \sim 72\text{V}$ unless otherwise specified

Parameter	Symbol	Min	Typ	Max	Unit
Output Voltage tolerance	V_o	-	-	2	%
Output Current	I_o				
SPTS15-48-3R3				4.0	A
SPTS15-48-5				3.0	A
SPTS15-48-12				1.25	A
SPTS15-48-15				1.0	A
Output Regulation;					
- Line Regulation (From minimum input voltage to maximum input voltage, constant load)		-	-	0.5	%
- Load Regulation (From no load to maximum load, Constant load)		-	-	1	%
Output Current Limit (Automatic recovery)		>105			%
Output Ripple and noise ($V_{in} = 48\text{V}$, and $I_o = \text{Max Output Current}$ Bandwidth 20MHz, 1uF Ceramic cap)	mVp-p	-	-	1% of V_{out}	mV
Efficiency					
SPTS15-48-3R3			86		%
SPTS15-48-5			86		%
SPTS15-48-12			87		%
SPTS15-48-15			86		%
(100% of max I_o , $V_{in} = 24\text{V}$)					

Dynamic Load Response (1uF Ceramic 50% to 100 %, 100% to 50%, $T_r = 100\mu\text{s}$)				3% of Output Voltage	mV
---	--	--	--	----------------------	----

SPT15 Series – Isolated DC/DC Converters
20 – 72Vdc Input, Maximum Power: 15W

 Data Sheet
 JUNE 1, 2011

Start – Up Time		-	-	10	ms
Turn – on overshoot		-	-	5	%
Maximum output capacitance					μF

Isolation Specifications

Parameter	Symbol	Min	Typ	Max	Unit
I/O Isolation Voltage (AC500V, 1 Min)					
- Input-Output:			-	500	VAC
- Input-Case:			-	500	VAC
- Output-case:			-	500	VAC
Isolation Resistance - Output-Case (at DC500V at 25°C And 70%RH for 1 min)	RISO	>100	-	-	M
Isolation Capacitance	CISO				pF

General Specifications

Parameter	Symbol	Min	Typ	Max	Unit
Switching Frequency			400		KHz
Remote ON/OFF control					
- Positive Logic					
On = high or open		2.5		5.5	VDC
Off = low		0		0.8	

Output voltage trim range			10		%
MTBF		5.1x10 ⁵			hrs
Dimensions(L x W x H)		1.3 x 1.0x 0.4			inch
Weight		-	25	-	Grams

SPT15 Series – Isolated DC/DC Converters
20 – 72Vdc Input, Maximum Power: 15WData Sheet
JUNE 1, 2011**Environmental**

Parameter	Symbol	Min	Typ	Max	Unit
Operating Temperature		-20		+71	°C
Operating Humidity (RH non-condensing)		5		95	%
Storage Temperature		-40		105	°C

Characteristic Curves

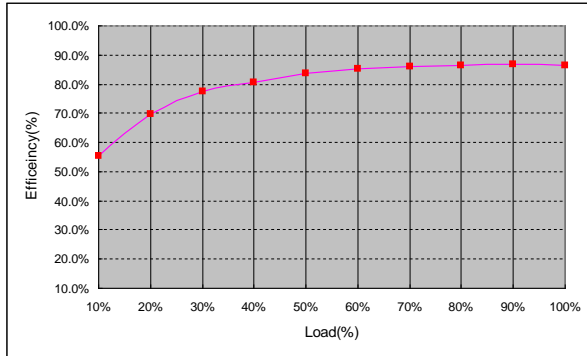
SPT15 Series – Isolated DC/DC Converters
20 – 72Vdc Input, Maximum Power: 15WData Sheet
JUNE 1, 2011**Efficiency Curves****SPTS15-48-3R3**

Vin=48V, Vo=3.3V@4A , At 25°C

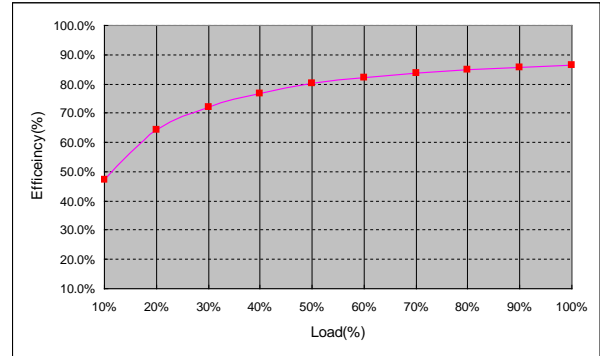
SPTS15-48-5

Vin=48V, Vo=5V@3A , At 25°C

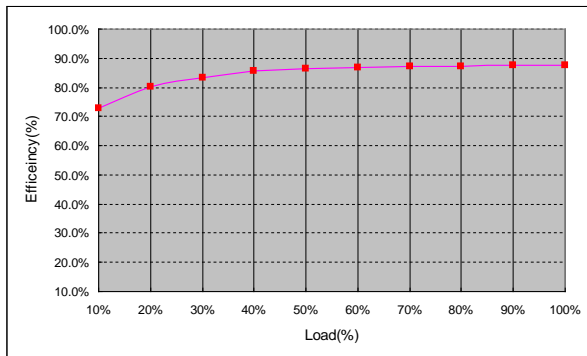
SPTS15-48-12

Vin=48V, Vo=12V@1.25A , At 25°C

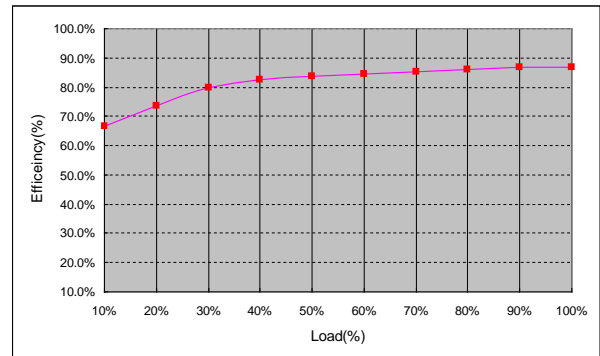
SPTS15-48-15

Vin=48V, Vo=15V@1.0A , At 25°C

SPT15 Series – Isolated DC/DC Converters
 20 – 72Vdc Input, Maximum Power: 15W

Data Sheet
 JUNE 1, 2011

Input Voltage vs Input Current

SPTS15-48-3R3

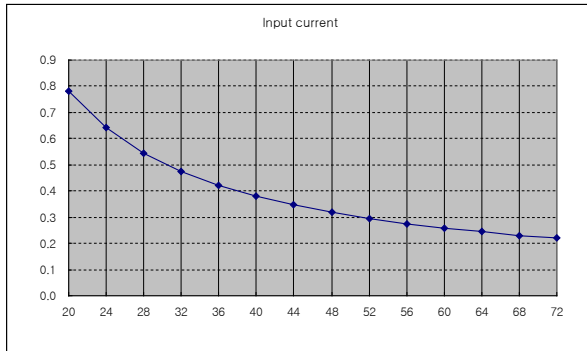

Vin=48V, Vo=3.3V@4A, At 25°C

SPTS15-48-12

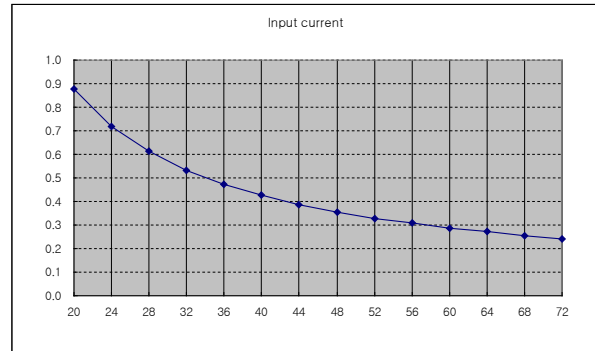

Vin=48V, Vo=12V@1.25A, At 25°C

SPTS15-48-5

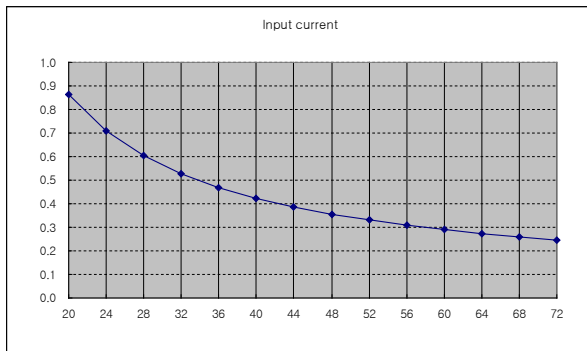

Vin=48V, Vo=5V@3A, At 25°C

SPTS15-48-15

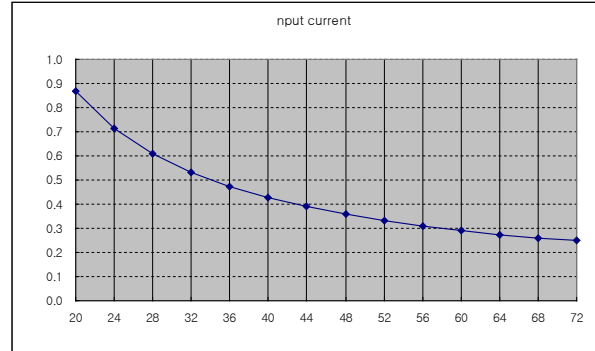

Vin=48V, Vo=15V@1.0A, At 25°C

SPT15 Series – Isolated DC/DC Converters
 20 – 72Vdc Input, Maximum Power: 15W

Data Sheet
 JUNE 1, 2011

Start-up from Vin

SPTS15-48-3R3

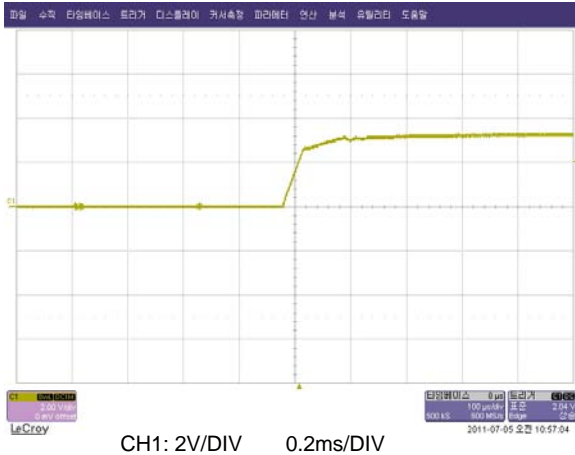

Vin=48V, Vo=3.3V@4A , At 25°C

SPTS15-48-5

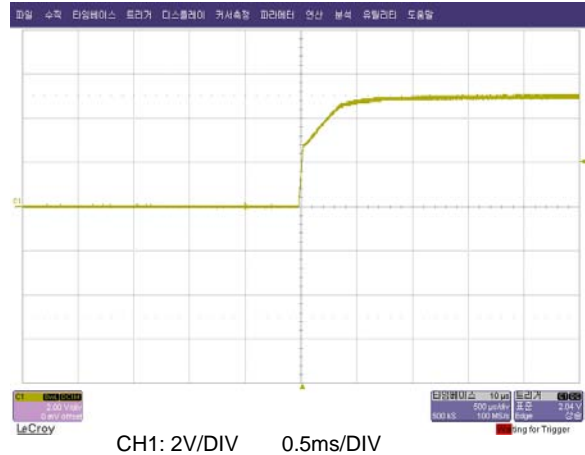

Vin=48V, Vo=5V@3A, At 25°C

SPTS15-48-12

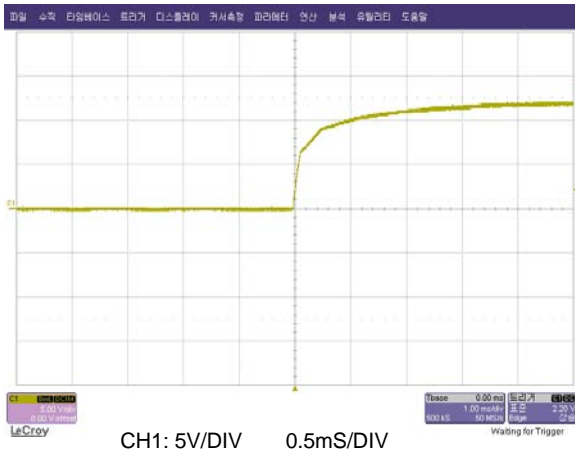

Vin = 48V, Vo=12V@1.25A, At 25°C

SPTS15-48-15

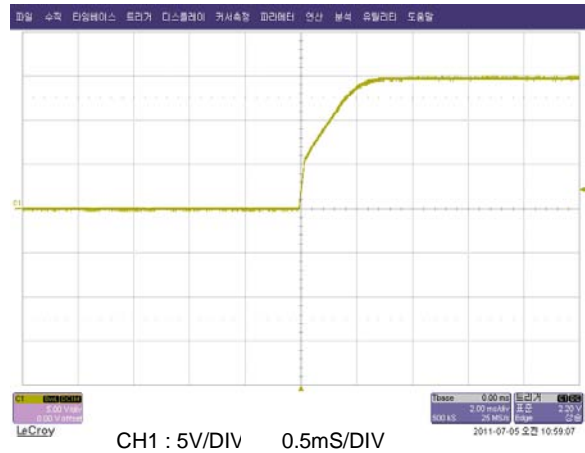

Vin = 48V, Vo=15V@1A, At 25°

SPT15 Series – Isolated DC/DC Converters
 20 – 72Vdc Input, Maximum Power: 15W

Data Sheet
 JUNE 1, 2011

Output Ripple/Noise

SPTS15-48-3R3

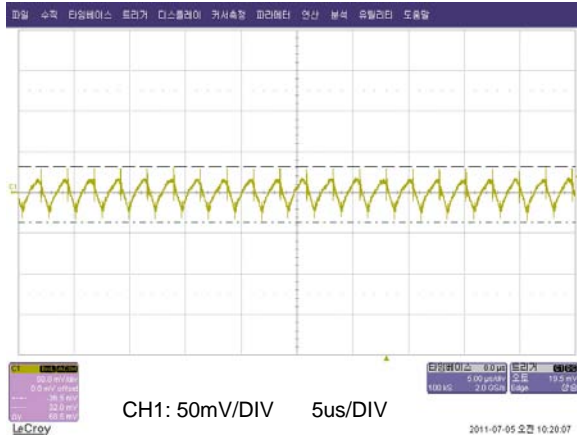

Vin=48V, Vo=3.3V@4A , At 25°C

SPTS15-48-5

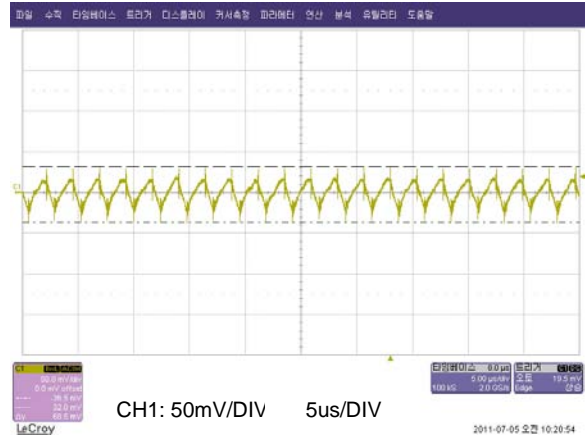

Vin=48V, Vo=5V@1.7A, At 25°C

SPTS15-48-12

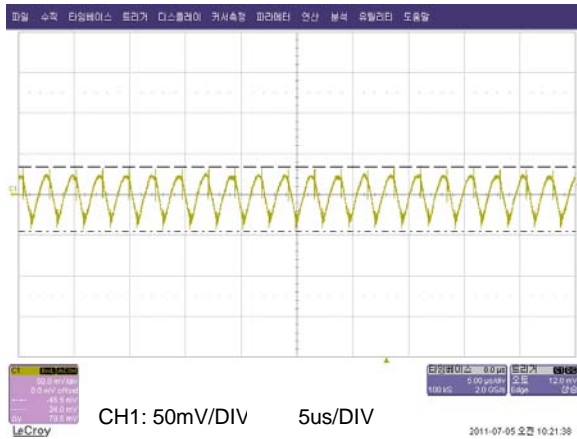

Vin = 48V, Vo=12V@1.25A, At 25°C

SPTS15-48-15

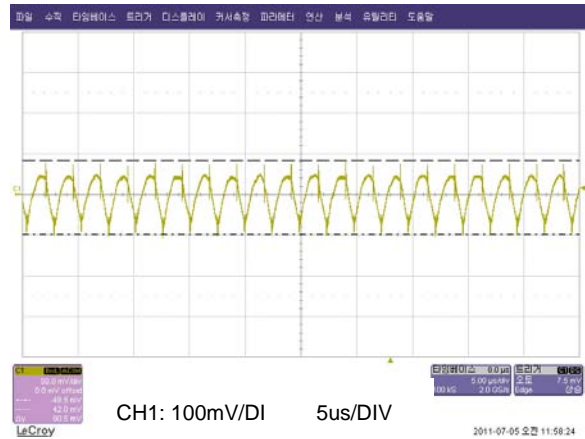

Vin = 48V, Vo=15V@1A, At 25°C

SPT15 Series – Isolated DC/DC Converters
 20 – 72Vdc Input, Maximum Power: 15W

Data Sheet
 JUNE 1, 2011

Output Load Transient Response

(Dynamic load change from 50% to 100% of full load)

SPTS15-48-3R3

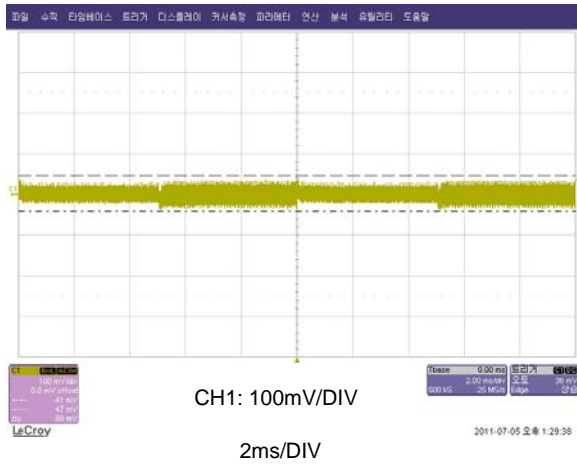

Vin=48V, Vo=5V

SPTS15-48-5

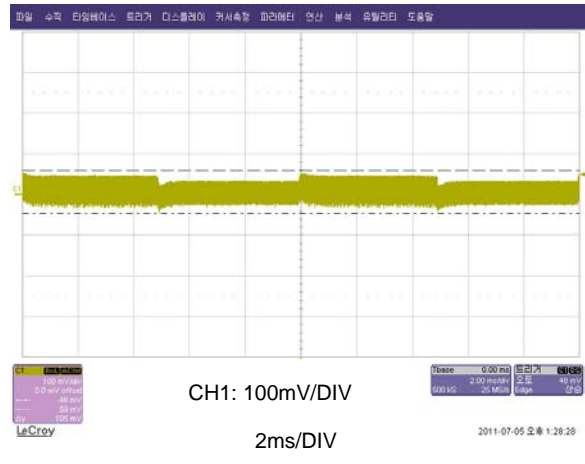

Vin=48V, Vo=12V

SPTS15-48-12

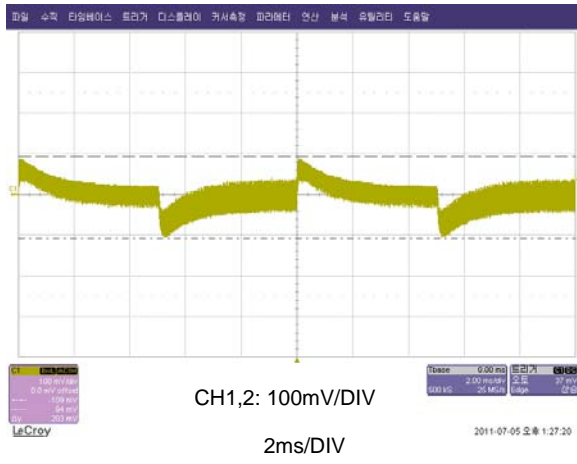

Vin = 48V, Vo=12V

SPTS15-48-15

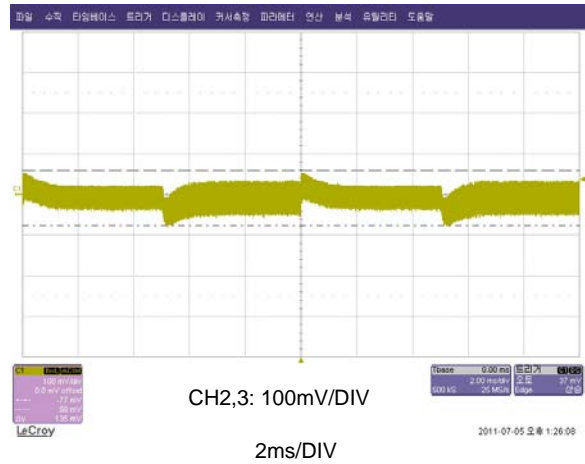

Vin=48V, Vo=15V

SPT15 Series – Isolated DC/DC Converters
 20 – 72Vdc Input, Maximum Power: 15W

Data Sheet
 JUNE 1, 2011

TEST Configurations

Input Reflected Ripple Current Test

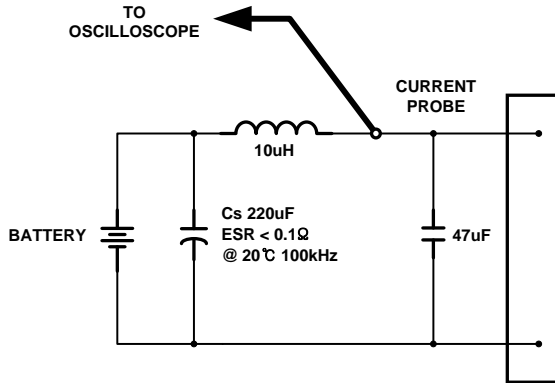

$$\eta = \left(\frac{[V_o(+)-V_o(-)] \times I_o}{[V_{in}(+)-V_{in}(-)] \times I_{in}} \right) \times 100\%$$

Thermal Considerations

SPTS15 series has wide operating temperature range from -20°C to +71°C.

However, it should be required a enough air flow for more reliable operation. Output derating curve provide designers with a quantity of a current under the desired ambient temperature and velocity of a airflow

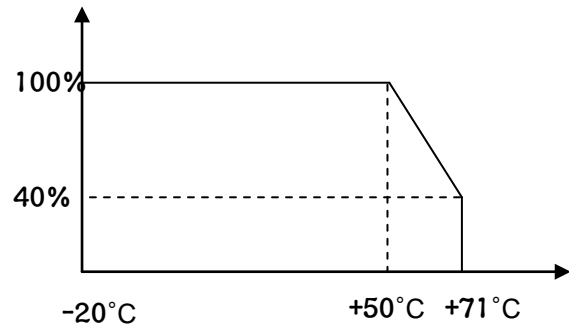

Output ripple and noise Test

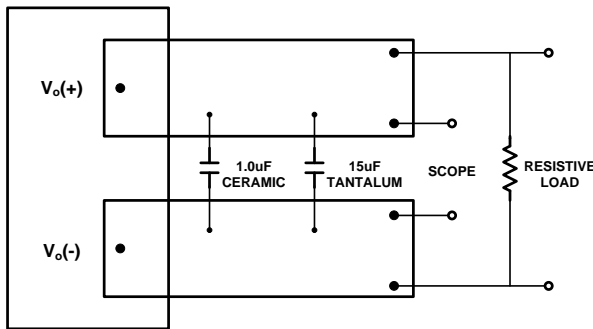

If the device is installed in a system, the device's temperature of point A should be checked if does not exceed specified temperature as below. Please make sure that the ambient temperature does not exceed 71°C.

* Conductor from Vout-pins to capacitors = 50mm (1.97in)

Output Voltage and Efficiency Test

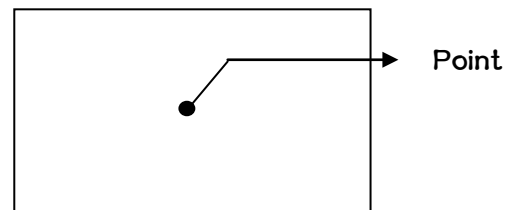
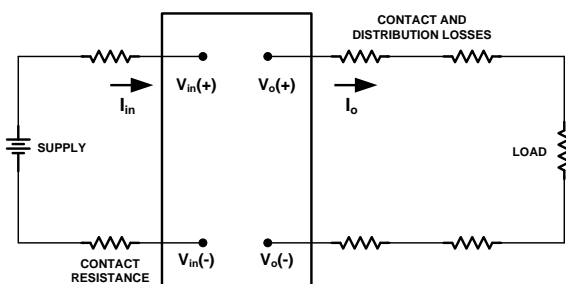

Output	15W		
Temperature of A	95°C		

*All measurements are taken at the module terminals when Socketing, place Kelvin connections at module terminals to Avoid measurement errors due to socket contact resistance

Efficiency

SPT15 Series – Isolated DC/DC Converters
 20 – 72Vdc Input, Maximum Power: 15W

Data Sheet
 JUNE 1, 2011

Feature Description

Input Fuse

SPT15 series has not built in internal fuse. Therefore in order to ensure protection and safety fuses should be used at input line of converter

We recommend to use a slow blow type fuse with a typical value of about twice the maximum input current, calculated at low line with the converter minimum efficiency.

Input Reverse-polarity voltage protection

Input reverse voltage protection has not built in this product.

So, you can set up a circuit externally as described below if necessary

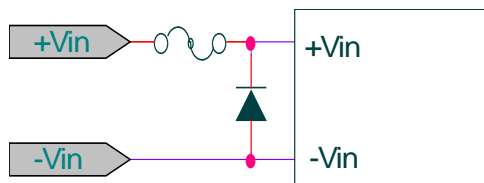

Input Output Filter

SPT15 series have an internal input filter. To minimize the ripple and noise of the input voltage, additional external capacitor is required (10uF ~ 680uF)

To reduce an output ripple and noise, external capacitor is required at the output of the device

Remote ON/OFF Control (CNT)

By using CNT pin you can control the output without turning the input power on or off.

If you need not this function open CNT Pin.

CNT Level for -Vin	OUTPUT
Open, High	ON
Low	OFF

Output voltage variation (Trim)

Output Voltage adjusted by using trim pin within 10% of output voltage.

Use of trim function can cause the output power to increase, so you should not use beyond the SPT15's specified output power rating

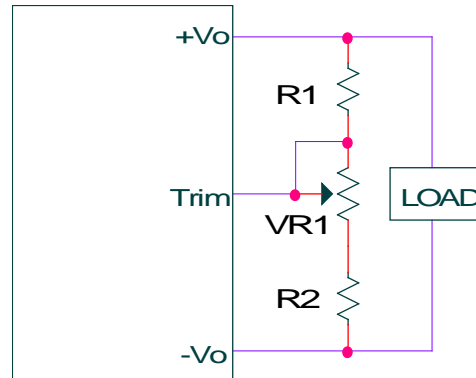

Output voltage	VR	R1	R2
3.3V	500	1k	560
5V	1k	1k	680
12V	1k	3.9k	680
15V	1k	5.6k	750

Over current Protection (OCP)

SPT15 Series – Isolated DC/DC Converters
20 – 72Vdc Input, Maximum Power: 15W

Data Sheet
 JUNE 1, 2011

SPT15 series built in over current protection circuit

Which operates when the output current is over 105% of rating and automatically recovers when over current condition is removed

If load is connected to a inductive or constant current load such as lamp or motor, output may not start up.

Over Voltage Protection (OVP)

SPT15 series has not built in overvoltage protection circuit. So, you need to set up a circuit externally which can protect the over voltage if necessary.

Soldering Information

The product is intended for through hole mounting in a PCB. When wave soldering is used, the temperature on the pins is specified to maximum 260°C for maximum 10 seconds.

When hand soldering, care should be taken to avoid direct contact between the hot soldering iron tip and the pins for more than a few seconds in order to prevent overheating.

EMI Characteristic (conducted Emission)

In order to reduce conducted noise install an external input filter as shown in below.

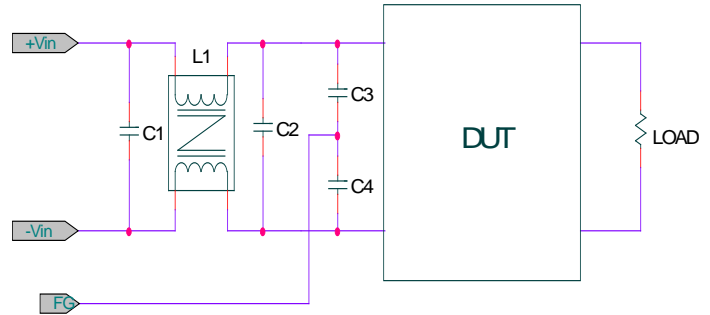

Model Number	L1	C1	C2	C3,C4
SPTS15-24-5	3mH	22uF	100uF	222
SPTS15-48-5	2mH	22uF	100uF	222

Complies with CISPR 22 CLASS B

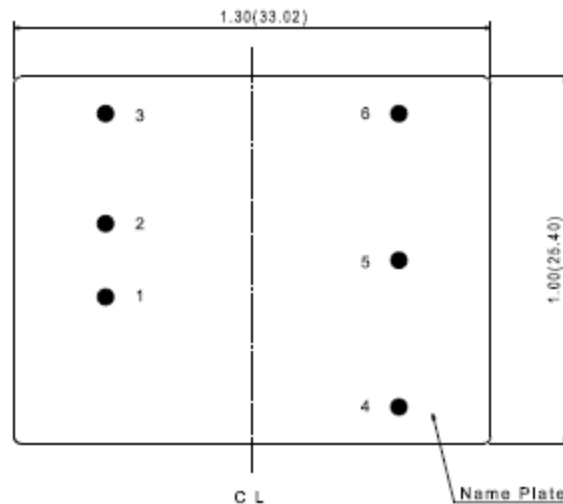
SPT15 Series – Isolated DC/DC Converters
20 – 72Vdc Input, Maximum Power: 15WData Sheet
JUNE 1, 2011**Pin assignments****Single Output**

PIN NO	NAME	FUNCTION
1	+Vin	Positive terminal for 24V
2	-Vin	Negative terminal for 24V
3	CNT	Logic signal reference to Vin to Turn the converter ON/OFF
4	+Vout	Positive terminal for Vout
5	Trim	Output voltage variation
6	-Vout	Negative terminal for Vout

Mechanical Specification

TOP VIEW

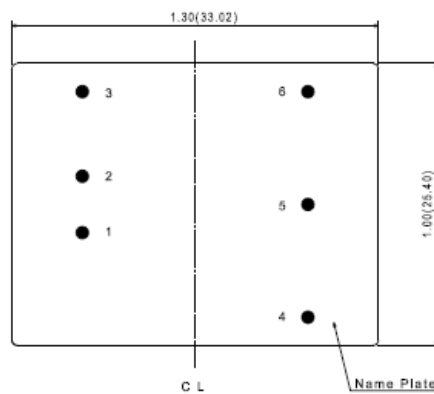

OTHER VIEW

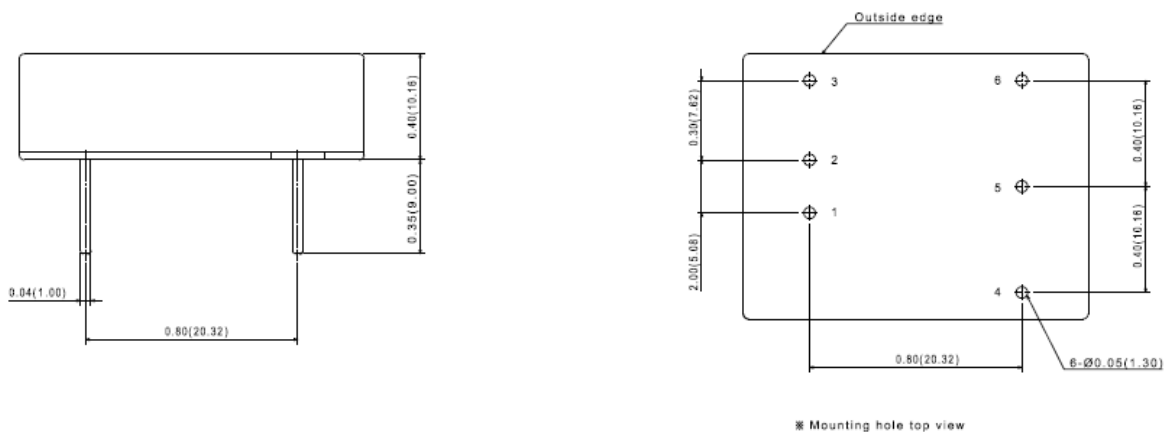

All dimensions are inches and mm

SPT15 Series – Isolated DC/DC Converters
20 – 72Vdc Input, Maximum Power: 15WData Sheet
JUNE 1, 2011**Ordering Information**

Input	Output1, Output2	Maximum Power	Ripple & Noise Typ.	Efficiency Typ.	Model Number
10 – 36V	3.3V@4A	13.2W	70mVp-p	83%	SPTS15-24-3R3
	5V@3A	15W	70mVp-p	85%	SPTS15-24-5
	12V@1.25A	15W	120mVp-p	87%	SPTS15-24-12
	15V@1A	15W	150mVp-p	86%	SPTS15-24-15
20 – 72V	3.3V@4A	13.2W	70mVp-p	86%	SPTS15-48-3R3
	5V@3A	15W	70mVp-p	86%	SPTS15-48-5
	12V@1.25A	15W	120mVp-p	87%	SPTS15-48-12
	15V@1A	15W	150mVp-p	86%	SPTS15-48-15

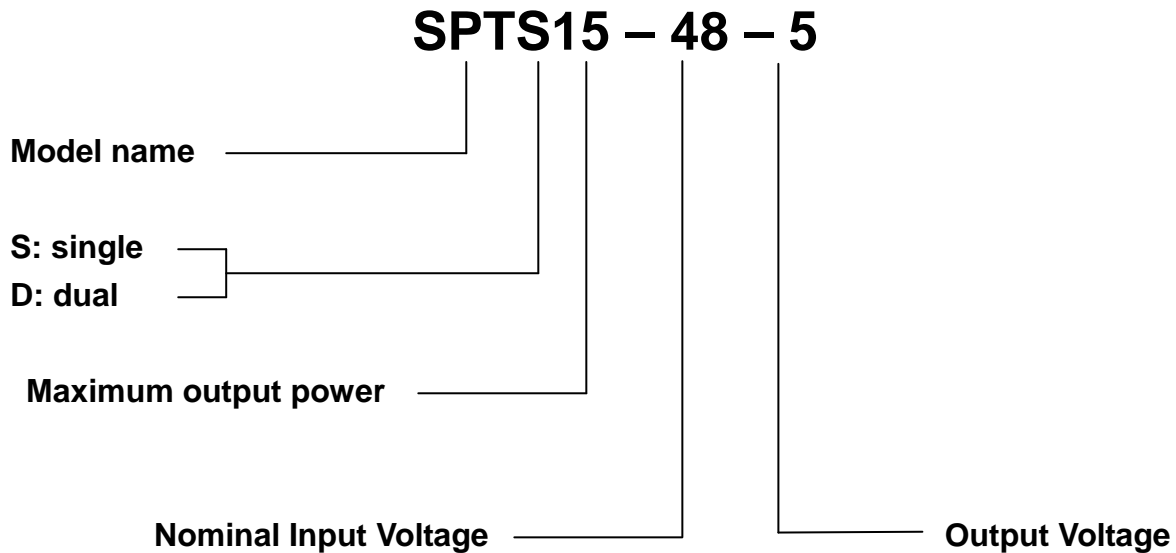
SPT15 Series – Isolated DC/DC Converters
20 – 72Vdc Input, Maximum Power: 15WData Sheet
JUNE 1, 2011**Part number structure**

No part of this publication may be copied, transmitted, or stored in a retrieval system Or reproduced in any way including, but not limited to, photography, photocopy, or Other recording means, without prior written permission from Powerplaza co.,Ltd

**HEAD OFFICE & FACTORY**

#1401, 14F/L 6th Daeryung TechnoTown 493-6,
Gasam-Dong, Kumchon-Gu, Seoul, 153-803,
Korea
TEL: +82 2 855 4955 | FAX: +82 2 855 4954

GENERAL SALES INQUIRIES

Please feel free to
contact : sales@powerplaza.co.kr

2007 Powerplaza co.,Ltd. Specification subject to change without notice